

5303-2402-0071 Spec Sheet

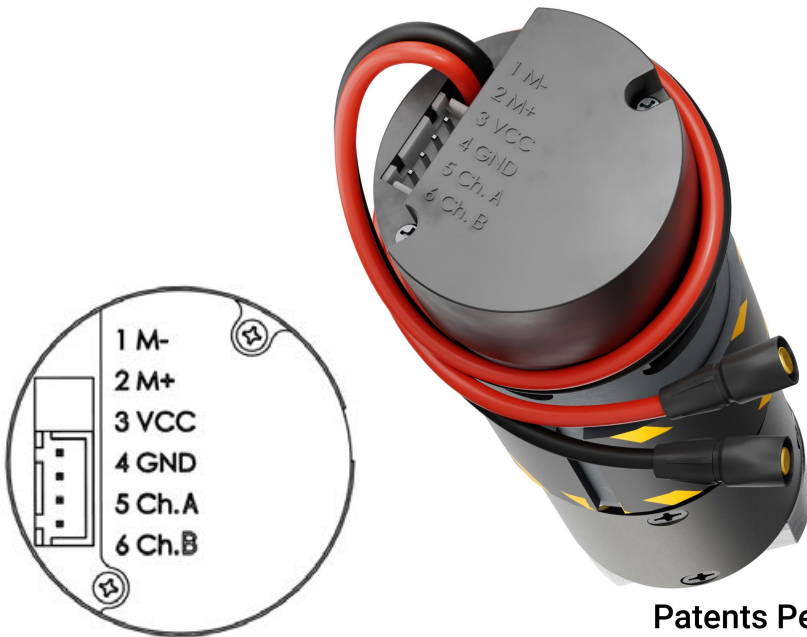

Patents Pending

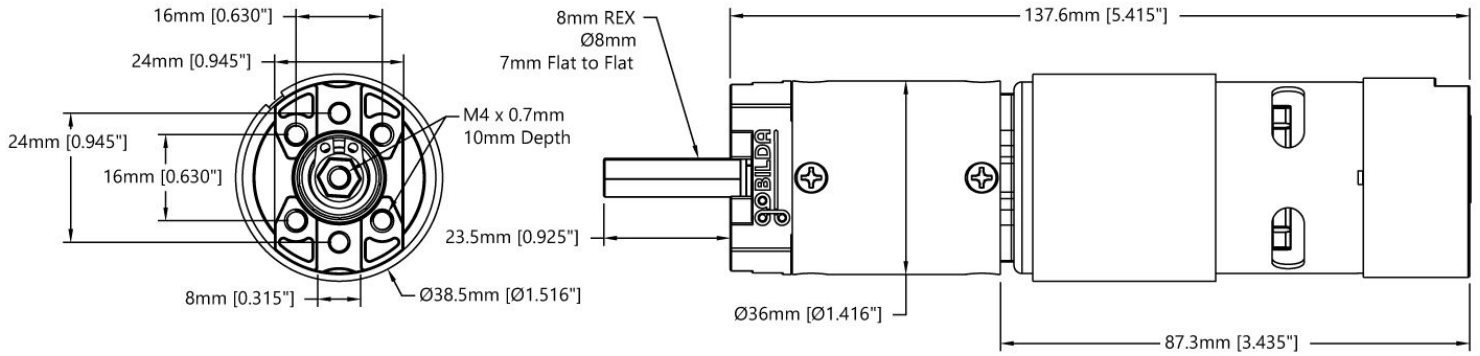

Patents Pending

Motor Size	RS-560
Motor Type	Brushed DC
Nominal Voltage	24VDC
Output Shaft	8mm REX, 23.5mm Length
Gearbox Style	Planetary
Nominal Gear Ratio	71.2:1
Gear Ratio Formula	$(1+(46/17)) * (1+(46/17)) * (1+(46/11))$
Gear Material	Steel
Wire Length	470mm (including connectors)

5303-2402-0071 Spec Sheet

Wire Gauge	18AWG
Motor Connector Type	3.5mm FH-MC Bullet Connectors
No-Load Speed	130 RPM @ 12VDC 230 RPM @ 20VDC 260 RPM @ 24VDC
No-Load Current	0.8A @ 12VDC 1A @ 20VDC 1.3A @ 24VDC
Stall Torque	2000 oz-in (144 kg.cm) @ 12VDC 2720 oz-in (196 kg.cm) @ 20VDC 3447 oz-in (248 kg.cm) @ 24VDC
Stall Current	30A @ 12VDC 45A @ 20VDC 60A @ 24VDC
Maximum Duty-Cycle @ Rated Torque	25% on, 75% off (Maximum 15 Minutes Continuous)
Rated Torque	358 oz-in (25.8 kg.cm) @ 12VDC 490 oz-in (35.2 kg.cm) @ 20VDC 619 oz-in (44.6 kg.cm) @ 24VDC
Speed at Rated Torque	107 RPM @ 12VDC 189 RPM @ 20VDC 213 RPM @ 24VDC
Current Draw at Rated Torque	6A @ 12VDC 8A @ 20VDC 11A @ 24VDC
Encoder Type	Relative, Quadrature
Encoder Sensor Type	Magnetic (Hall Effect)
Encoder Voltage Range	3.3-5VDC
Encoder Resolution	1,993.6 PPR at the Output Shaft
Encoder Resolution Formula	$(1+(46/17)) * (1+(46/17)) * (1+(46/11)) * 28$
Encoder Connector Type	4-Pos JST XH [FH-MC]
Weight	541g
IP	Patents Pending

Saturn Planetary Gear Motor Spec Sheet

Glossary Of Terms

No-Load Speed: The speed the motor will spin at, given the indicated input voltage with nothing attached to the output shaft. When load is applied, the motor will spin slower.

No-Load Current: The amount of current the motor will draw given the indicated input voltage with nothing attached to the output shaft. When load is applied, the motor will pull more current.

The motor will pull more current when accelerating. No-Load Current should not be used to select a power source to operate a motor.

Stall Torque: The absolute maximum amount of torque the motor can produce. Motor stall occurs when the load is so great that the motor is unable to move. The power output of this motor is so high that stalling it, even momentarily, will damage the motor. When determining what motor to use for your application, use Rated Torque instead of Stall Torque.

Stall Current: The absolute maximum amount of current the motor can draw. This only happens when the motor is under so much load that it is unable to move. Even though stalling this motor even momentarily will damage it, current draw up to the Stall Current is possible for short bursts when accelerating the motor.

Maximum Duty-Cycle at Rated Torque: The amount of time the motor needs to cool off after it's been run. Duty cycle is expressed as two percentages: an "on time" (the amount of time the motor is running) and an "off time" (the amount of time the motor needs to cool off).

The maximum amount of time a Saturn Planetary Gear Motor should be run continuously is 15 minutes; a 45 minute rest is required after the motor is run. This creates a maximum period of 1 hour.

If your application requires a shorter runtime, the cool off period can be shorter as well. Running the motor at Rated Torque for 5 minutes requires a 15 minute rest to keep a 25% on, 75% off Duty Cycle.

If your application requires less than the motor's rated torque, the duty cycle can be increased. But take extreme care when doing this, as increasing it too much will cause the motor to overheat and sustain damage.

Rated Torque: The maximum torque the motor can output when it is used within its Duty Cycle. This rating is tested at an ambient temperature of 21°C (70°F).

Speed at Rated Torque: The speed that the motor will run at when its load equals the motor's Rated Torque.

Current Draw at Rated Torque: The amount of current that the motor will draw when its load equals the motor's Rated Torque.

Saturn Planetary Gear Motor Spec Sheet

Motor Curves

A motor curve can be used to estimate the speed, current draw, efficiency, and output power of a motor when a certain load is applied.

This curve is used for all Saturn Series motors. The torque and speed are shown as a percentage of the maximum torque and speed. For example, a 5303-2402-0188 has a maximum speed of 100 RPM at 24V, and a maximum torque of 658 kg.cm at 24V. These two characteristics are inversely proportional, as torque load increases speed decreases.

If you know the torque load being applied to your motor, use the motors stall torque spec to find what percentage of the maximum torque your load applies. Then refer to this chart to estimate the speed, efficiency, and output power of the motor at this load. If the resulting characteristics are not what is desired, changing to a different gearbox ratio in the same motor series will change the applied torque to the bare motor and change the resulting performance. Be mindful to not exceed the motor's maximum rated torque.

These Motor Curves do not account for changes in voltage as current is pulled. This is most commonly experienced as voltage sag from a battery. If you're using a battery, you may see decreased performance as the voltage is pulled lower due to the current draw from the motor.

These motor curves are designed to characterize the motor at 21°C (70°F). As the motor's internal temperature increases, performance may decrease.

These motor curves are estimations, and we do not guarantee the performance of a motor in a specific application.

5303/5304 Series Saturn Planetary Gear Motors @ 24VDC

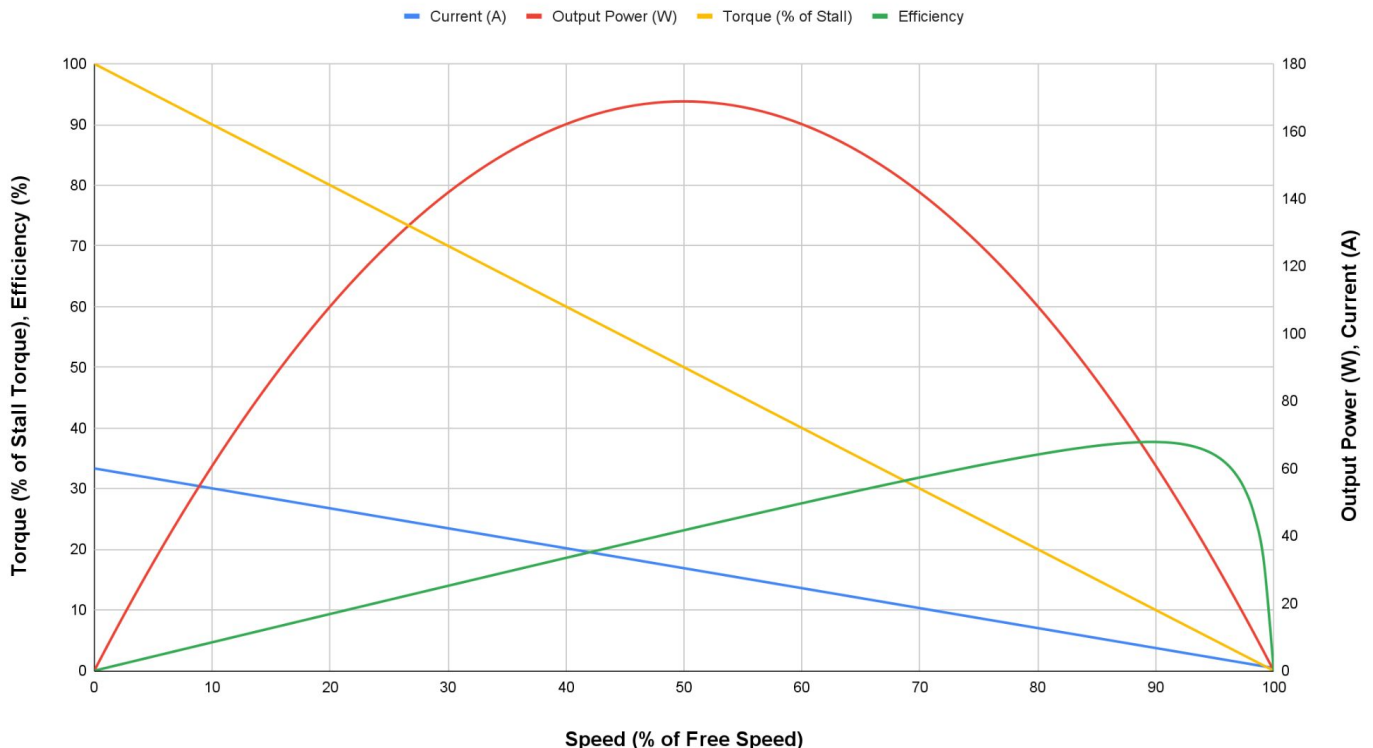

Saturn Planetary Gear Motor Spec Sheet

5303/5304 Series Saturn Planetary Gear Motors @ 20VDC

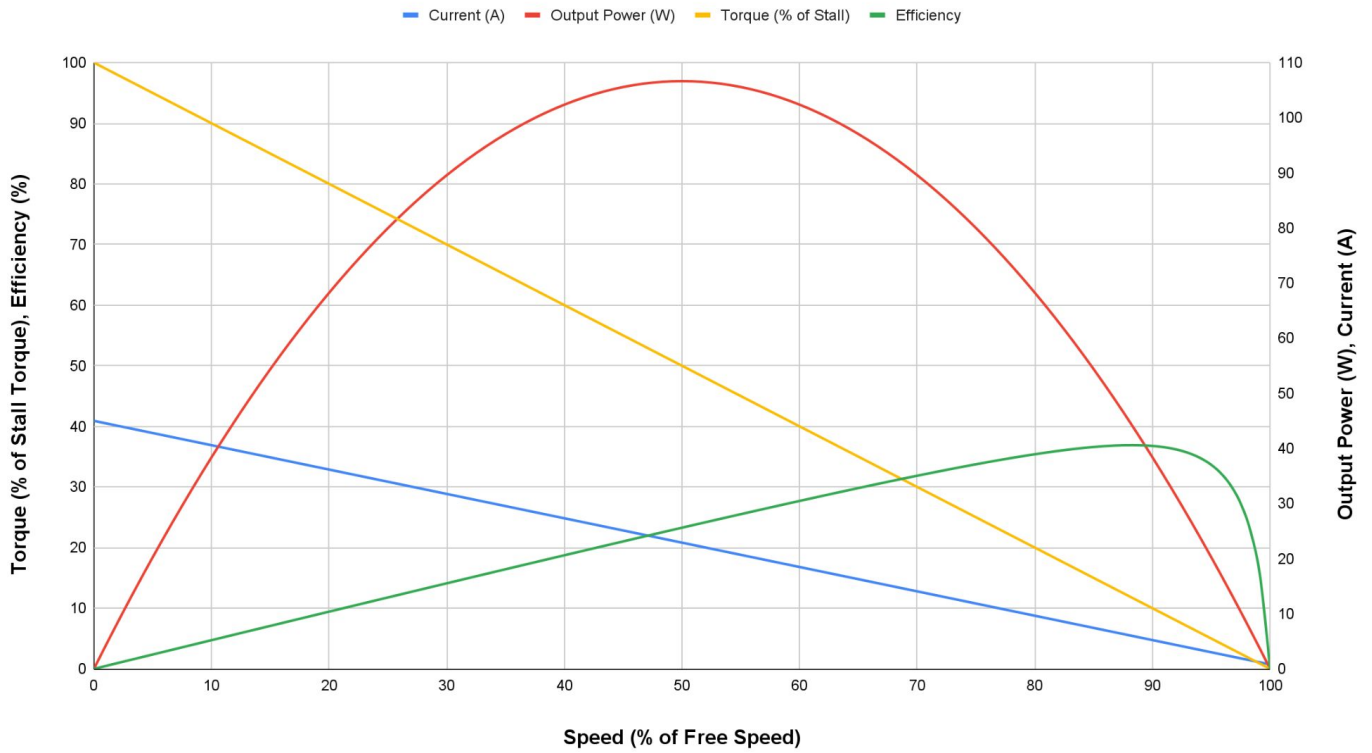

5303/5304 Series Saturn Planetary Gear Motors @ 12VDC

